

## PANDICON\* INDICATOR TUBE

Long-life, multiple cold-cathode, gas-filled indicator tube for in-line numerical display applications requiring a large number of digits (up to 14) to be displayed on a minimum of space, e.g. in electronic desk-top calculators. To facilitate the reading of large numbers, punctuation marks can be made to appear at suitable places.

QUICK REFERENCE DATA			
Numeral height			10 mm
Numerals		0 1 2 3 4 5 6 7 8 9	
Number of decades			14
Decimal points		to the lower right of the numerals	
Punctuation marks		to the upper right of the numerals	
Decade pitch			10 mm
Supply voltage, peak	$V_{bap}$	min.	170 V
Anode current, peak	$I_{ap}$		9 mA

### GENERAL

The numerals are 10 mm high and appear on the same base-line allowing in-line read-out.

### DIMENSIONS AND CONNECTIONS

Dimensions in mm

Base: B17A (2x)

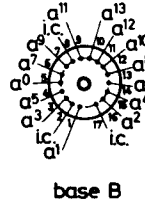
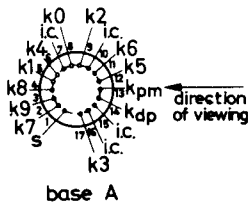
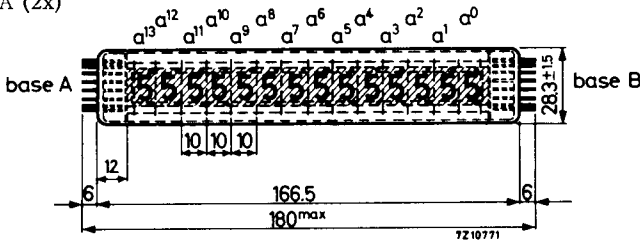

No undue stress should be placed on the base pins.

\*Registered Trade Mark for multiple indicator tubes.  
Data based on pre-production tubes.

## PRINCIPLE OF OPERATION

The tube contains 10 common numeral cathode rails, one common decimal point cathode rail, one common punctuation-mark cathode rail, a common screen and 14 decade anodes.

The application of a suitable coincidence voltage (pulse) on the cathode rail and on one anode causes the selected numeral to light up in the desired decade. Sequential drive of either the cathode rails or the anodes, whilst simultaneously selecting the corresponding anode or cathode, respectively, with a minimum cycling frequency of approximately 70 Hz allows flicker-free numerical presentation.

In a practical circuit both the "off" anodes and the "off" cathodes are to be kept in the quiescent state by a bias voltage in such a way that they will neither act as cathodes nor as anodes.

The cathode numeral (with or without decimal point and/or punctuation-mark) to be selected is to be driven negative and the anode to be selected positive with respect to the bias.

The screen must be kept at a steady potential during operation to prevent "cross-talk" between the decades. (See basic circuit).

Remark: Because a gas discharge is not current limiting in itself, the electrode currents must be limited to safe values by using resistors or (limited) current sources.

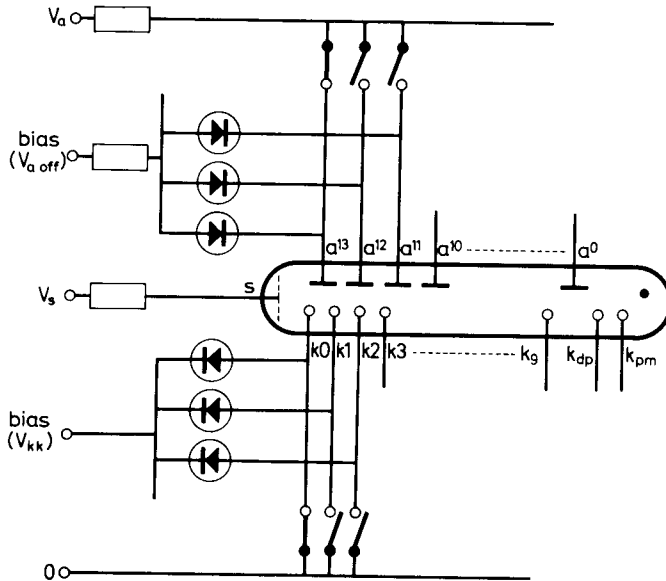

Basic circuit

Pertinent application information is available on request.

**CHARACTERISTICS AND OPERATING CONDITIONS**

Ignition voltage	$V_{ign}$	max.	170	V
Ignition delay, first ignition subsequent ignitions	$T_d$ typ. $T_d$	max.	0.5	s
			10	$\mu s$
Anode current, peak				
with or without decimal point and/or punctuation mark at $T_{imp} = 50 \mu s$	$I_{ap}$	min.	6	mA
at $T_{imp} = 150 \mu s$		min.	5	mA
at $T_{imp} = 1000 \mu s$		min.	4	mA
		max.	12	
Recommended pulse duration	$T_{imp}$	150 to	500	$\mu s$
Maintaining voltage	$V_m$	see page 5		
Cathode selecting voltage	$V_{kk}$	min.	70	V 1)
		max.	100	V
"Off" anode voltage	$V_{aoff}$	min.	85	V
		max.	115	V
Recommended screen voltage	$V_s$	10 V below $V_{aoff}$		
Decimal point resistor 2)	$R_{dp}$		10	$k\Omega \pm 10\%$
Punctuation mark resistor 2)	$R_{pm}$		10	$k\Omega \pm 10\%$

1) At lower values of  $V_{kk}$  the contrast of the display will be reduced due to glow on adjacent numerals. This will not affect the life of the tube.

After switching the bias should be restored within 20  $\mu s$ .

2) The decimal point and/or punctuation mark cathode(s) may not be operated without extra current limiting resistor.

**LIFE EXPECTANCY AND RELIABILITY**

The life is inversely proportional to the instantaneous value of the peak operating current and on the pulse repetition operating frequency. Due to the extreme longevity this proportionality is not expected to show within the first three years of operation within the ratings.

Accelerated life tests (high peak current, frequency and duty cycle) have indicated a life expectancy well in excess of 50 000 operating hours in a typical application. Integration of 14 full decades and the associated interconnections in a single package improves the mechanical reliability by a factor of 7 to 14 compared to a row of 14 individual indicator tubes.

Minimum Mean Time Between Failures is estimated to be 500 000 operating hours.

**LIMITING VALUES** (Absolute max. rating system)

Anode supply voltage	$V_{ba}$	min. 170 V max. 220 V
Anode current, peak each anode with or without decimal point and/or punctuation mark at $T_{imp} = 50 \mu s$ at $T_{imp} = 100 \mu s$ at $T_{imp} = 1500 \mu s$	$I_{ap}$	min. 6 mA min. 5 mA min. 4 mA
average ( $T_{av} = 1 s$ )	$I_{ap}$ $I_a$	max. 12 mA max. 1.5 mA
Anode current, peak; decimal point or punctuation mark only 2) average ( $T_{av} = 1 s$ )	$I_{ap}$ $I_a$	min. 0.5 mA max. 2 mA max. 0.25 mA
Pulse duration	$T_{imp}$	min. 50 $\mu s$
Cathode selecting voltage	$V_{kk}$	max. 100 V
"Off" anode voltage	$V_{aoff}$	min. 85 V max. 115 V
Screen voltage	$V_s$	min. 70 V max. 100 V
Voltage between any pair of electrodes (operating anode excluded)	$V$	max. 120 V
Ambient temperature	$t_{amb}$	min. -50 °C 1) max. +70 °C

1) Bulb temperatures below 10 °C result in a reduced life expectancy and changes in characteristics.

2) See page 3.

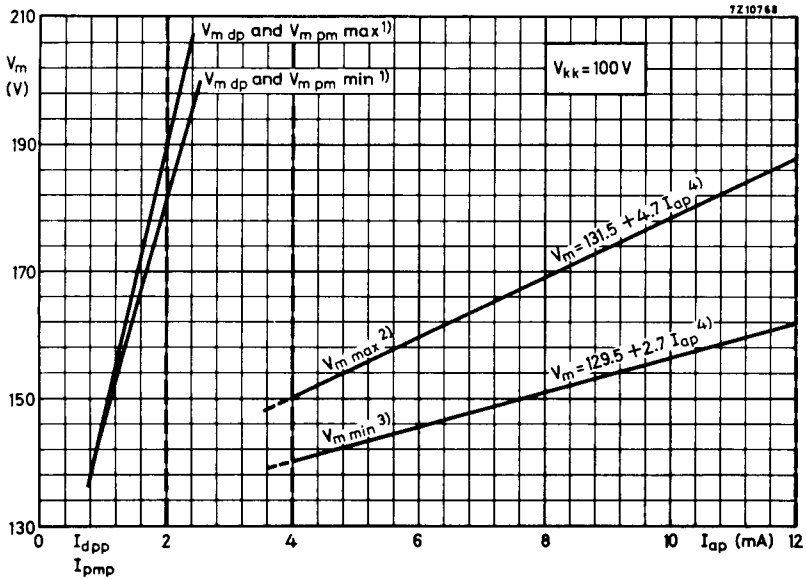
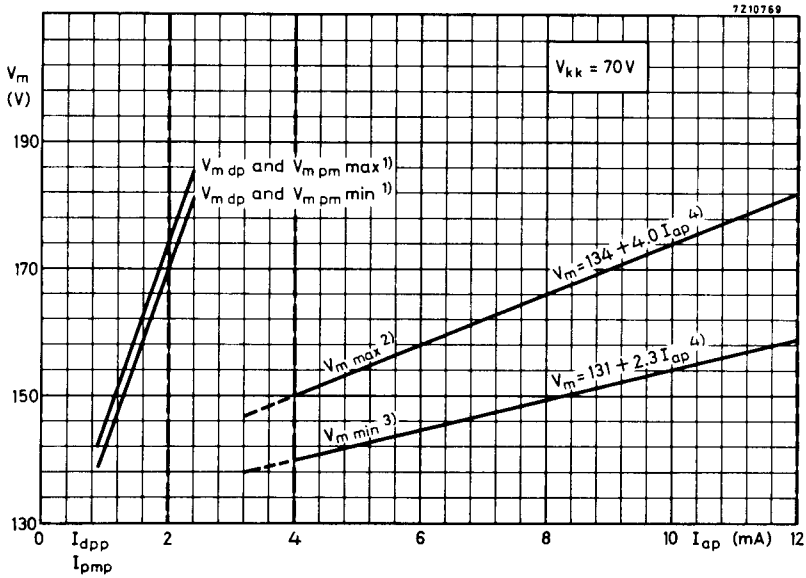

Notes see page 6

Notes to page 5

- 1) The decimal point maintaining voltage  $V_{M,DP}$  and the punctuation mark maintaining voltage  $V_{M,PPM}$  include the voltage drop at the 10 kΩ series resistor.
- 2)  $V_{M, max.}$  pertains to the maximum operating temperature and assumes the decimal point or punctuation mark operating.
- 3)  $V_{M, min.}$  pertains to the minimum operating temperature and assumes the decimal point or punctuation mark not operating.
- 4) The maintaining voltage can be considered as the sum of a constant voltage and a current dependent voltage (V/mA).

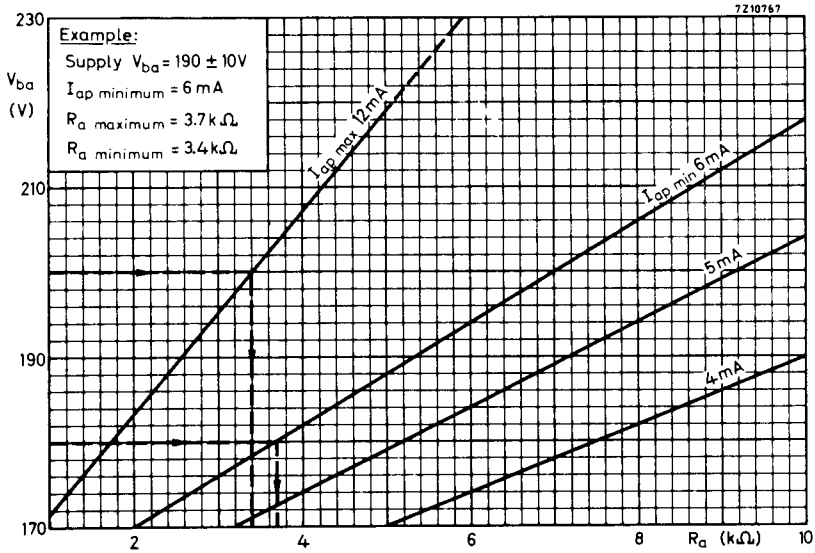

Plot of anode supply voltage versus anode resistance required to make the tube operate in a certain region (between 12 mA and 4 mA, or 12 mA and 5 mA, or 12 mA and 6 mA), depending on pulse duration. (See "Characteristics and operating conditions").

7 Z10770

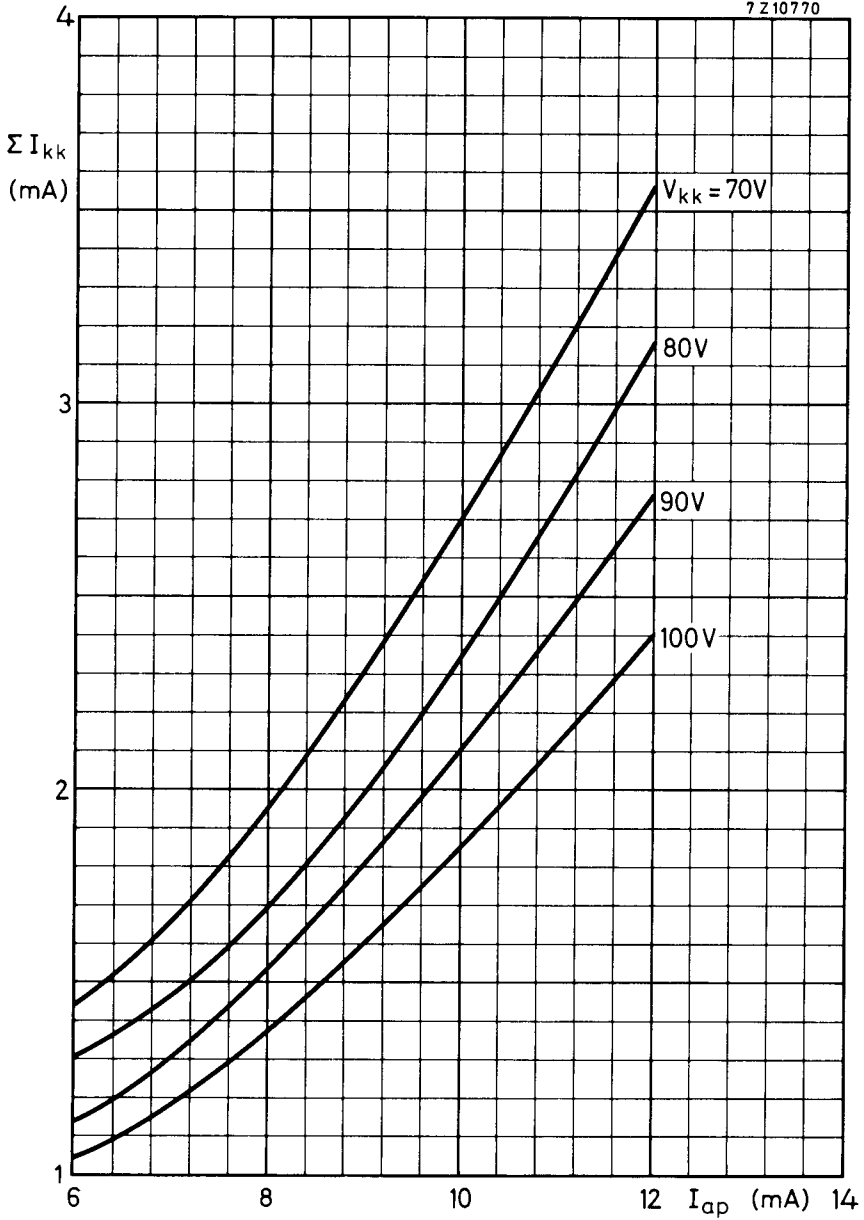

# PHILIPS

Data handbook



Electronic  
components  
and materials

## ZM1200

<b>page</b>	<b>sheet</b>	<b>date</b>
1	1	1970.04
2	2	1969.11
3	3	1970.04
4	4	1969.11
5	5	1969.11
6	6	1969.11
7	7	1969.11
8	FP	2000.04.22